

Mathematics vocabulary list Year 4



Maths is its own language. Sometimes that language looks like written word and sometimes it looks like symbols, but it is a language and it must be learned for math fluency and competency. If your child does not have a good understanding of key mathematical vocabulary, it can hinder them in making good progress in maths and in other areas of the curriculum.



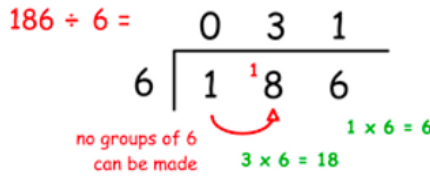
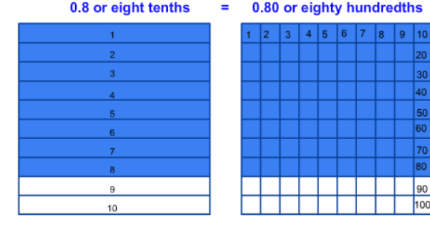
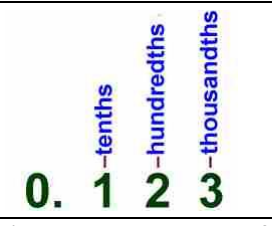
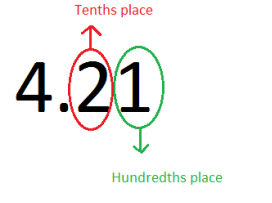

At Grace Mary, we explicitly teach maths vocabulary, giving it a context and allowing children to apply it in a variety of problems.

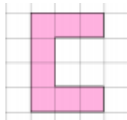



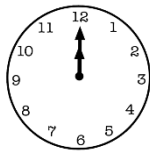

Listed below are the key mathematical terms your child will learn this year. This is the minimum we expect children to learn; however, we know children are curious and will undoubtedly want to learn more and we encourage this.

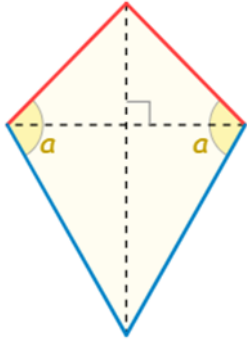

<u>Vocabulary</u>	<u>Definition</u>	<u>Example</u>
<i>Number and Place Value</i>		
Consecutive	Following each other continuously	'1, 2, 3, 4, 5...' '789, 790, 791, 792' <i>These are example of consecutive numbers'.</i>
Expression	One or a group of numbers, symbols or operators. An expression does not use equality or inequality signs. Using an equality or inequality sign will give an equation.	' 2×3 4^2 '
Integer	A whole number that can be positive or negative.	'6 is an integer , 0.6 is not.'
Negative numbers	A number that is less than zero.	'-1, -24, -0.5'.
Positive number	A number that is greater than zero. Zero is neither positive or negative.	'3, 32, 0.5.'
Thousand, ten thousand, hundred thousand, million	' 10,000- ten thousand. 100,000- one hundred thousand. 1,000,000- one million '.	
<i>Addition and subtraction</i>		
Associative law	No matter how the parts in an addition or multiplication equation are grouped, the answer will be the same.	' $(6 + 3) + 2 = 11$ $6 + (3 + 2) = 11$ <i>Addition and multiplication are associative. Subtraction and division are not.'</i>

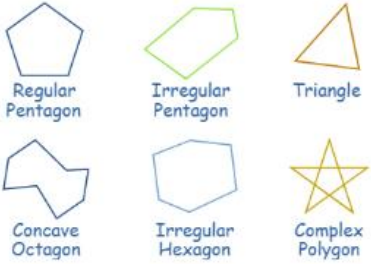
Multiplication and division		
Distributive law	The process whereby adding some numbers and then multiplying the sum gives the same answer as multiplying the numbers separately and then adding the products.	' $39 \times 7 = 30 \times 7 + 9 \times 7$. <i>This is an example of the distributive law.</i>
Short division	A formal written layout where the quotient is calculated showing only one written step.	$186 \div 6 =$ 
Short multiplication	A formal written layout where the multiplier is usually 9 or less.	$\begin{array}{r} 782 \\ \times \quad 9 \\ \hline 7038 \end{array}$
Fractions		
Decimal equivalent	Two decimal numbers that are equivalent, that is, they represent the same value or amount.	<p>0.8 or eight tenths = 0.80 or eighty hundredths</p> 
Decimal fraction	A fraction expressed in its decimal form.	'Half written as a decimal fraction is 0.5.'
Decimal place	The position of a digit to the right of a decimal point.	
Decimal point	A full point or dot placed after the figure representing units in a decimal fraction.	'7.89 is an example of a number with a decimal point '.
Hundredths	Each of one hundred equal parts into which something is or may be divided.	
Mixed number	Numbers consisting of an integer and fractional part.	' $1 \frac{1}{2}$ is a mixed number '.
Proper fraction	A fraction with a value less than one.	' $\frac{1}{2}$ and $\frac{3}{4}$ are proper fractions '.

Proportion	Harmonious relation of parts to each other or to the whole.	$\frac{a}{b} = \frac{c}{d}$
Simplify	To write a number or equation in its simplest form.	'I can simplify 8/10 to 4/5'
Length		
Area	The space a surface takes up inside its perimeter. Area is always measured in square units.	 <p>The area is 8 square units.</p>
Breadth	The distance or measurement from side to side of something	
Convert	To change from one unit of measurement to another.	'2 km can be converted to metres – it is equal to 2000 m.'
Square centimetre	A unit of measure for area equal to a square with the dimensions 1 cm by 1cm.	'Sometimes referred to as centimetre squared, abbreviated to cm² .'
Weight		
Mass	Mass is commonly measured by how much something weighs.	'How much do those apples weigh? What is their mass ?'
Weight	Weight is the measure of how heavy an object is.	'The weight of those rocks is 750g'.
Capacity and volume		
Measuring cylinder	Measuring cylinders are for holding and measuring varying amounts of liquids.	
Temperature		

Time																																																			
Arrive	Reach a place at the end of a journey or a stage in a journey.	'The bus arrives at 10am. It left the depot at 9.15am. How long was its journey?'																																																	
Depart	Leave, especially in order to start a journey.	'The bus departs at 10.15am. It takes 1 hour and 20 minutes to get to its next destination. What time will it arrive?'																																																	
Leap year	A year, occurring once every four years, which has 366 days including 29 February as an extra day.	'How many days are there in a leap year ?'																																																	
Millennium	A period of 1,000 years.	'How many years in a millennium ?'																																																	
Noon	Twelve O'clock in the day. Midday.																																																		
Timetable	A chart showing the departure and arrival times of trains, buses, or aircraft.	 <table border="1" style="margin-left: auto; margin-right: auto;"> <caption style="text-align: center;">BUS TIMETABLE</caption> <tbody> <tr> <td>Newport</td> <td>06:50</td> <td></td> <td>07:25</td> <td>08:45</td> <td>09:10</td> <td>09:45</td> </tr> <tr> <td>Underwood</td> <td>07:00</td> <td>07:25</td> <td>07:41</td> <td>08:55</td> <td>09:19</td> <td>09:53</td> </tr> <tr> <td>Magor</td> <td>07:11</td> <td>07:41</td> <td>07:51</td> <td>09:04</td> <td>09:31</td> <td>10:02</td> </tr> <tr> <td>Rogiet</td> <td>07:18</td> <td>07:59</td> <td>07:59</td> <td>09:11</td> <td>09:38</td> <td>10:11</td> </tr> <tr> <td>Caldicot</td> <td>07:29</td> <td>08:12</td> <td>08:09</td> <td>09:16</td> <td>09:47</td> <td>10:16</td> </tr> <tr> <td>Portskewett</td> <td>07:33</td> <td>08:15</td> <td>08:14</td> <td>09:20</td> <td>09:53</td> <td>10:21</td> </tr> <tr> <td>Chepstow</td> <td>07:45</td> <td>08:30</td> <td>08:30</td> <td></td> <td>10:05</td> <td>10:40</td> </tr> </tbody> </table> <p style="text-align: center; font-size: small;">Write the Questions and Answers in your book</p>	Newport	06:50		07:25	08:45	09:10	09:45	Underwood	07:00	07:25	07:41	08:55	09:19	09:53	Magor	07:11	07:41	07:51	09:04	09:31	10:02	Rogiet	07:18	07:59	07:59	09:11	09:38	10:11	Caldicot	07:29	08:12	08:09	09:16	09:47	10:16	Portskewett	07:33	08:15	08:14	09:20	09:53	10:21	Chepstow	07:45	08:30	08:30		10:05	10:40
Newport	06:50		07:25	08:45	09:10	09:45																																													
Underwood	07:00	07:25	07:41	08:55	09:19	09:53																																													
Magor	07:11	07:41	07:51	09:04	09:31	10:02																																													
Rogiet	07:18	07:59	07:59	09:11	09:38	10:11																																													
Caldicot	07:29	08:12	08:09	09:16	09:47	10:16																																													
Portskewett	07:33	08:15	08:14	09:20	09:53	10:21																																													
Chepstow	07:45	08:30	08:30		10:05	10:40																																													
2d shape																																																			
Construct	Build or make.	'Can you use these art straws to construct an irregular pentagon?'																																																	
Equilateral	Having all sides the same length.	'An equilateral triangle has three equal sides'.																																																	
Heptagon	A plane figure with seven straight sides and angles.																																																		
Isosceles	Having two sides of equal length. Isosceles triangles have two equal sides; isosceles trapezia have two equal, non-parallel sides.																																																		

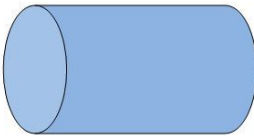
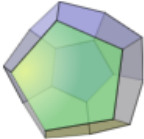
Kite	<p>A flat shape with 4 straight sides that:</p> <ul style="list-style-type: none"> • has two pairs of equal length sides. • each pair is made of two adjacent sides (they meet) that are equal in length. <p>The angles are equal where the pairs meet.</p>	
Oblong	A rectangle that is not a square.	
Parallelogram	A 2-D shape that has two pairs of parallel sides and equal opposite angles.	
Polygon	A plane shape (two-dimensional) with straight sides.	
Rectilinear	A rectilinear shape has straight line edges which are perpendicular (all meet at right angles).	<p><i>'A rectilinear- a straight-sided shape that can be divided up into other rectangles.'</i></p> 
Rhombus	An equilateral parallelogram with four equal length sides.	
Scalene	A scalene triangle has three unequal sides and three unequal angles.	
Trapezium	A quadrilateral with exactly one pair of parallel sides.	

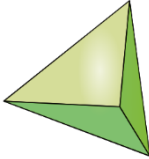
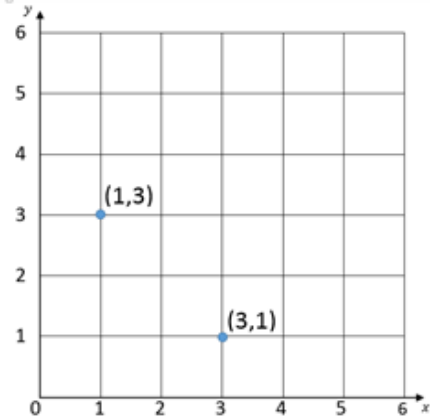
3d shape		
Cylindrical	Like a cylinder.	
Polyhedron	A solid with flat faces. Each flat face is a polygon.	
Spherical	Shaped like a sphere.	
Tetrahedron	A polyhedron (a flat-sided solid object) with 4 faces.	
Position and direction		
Coordinate	The position of a point, usually described using pairs of numbers.	<p>'The coordinate (1,3) describes a point that is 1 on the x axis and 3 on the y axis.'</p> 
Degree	A measure for angles. There are 360 degrees in a full rotation.	'There are 180 degrees in a triangle'.

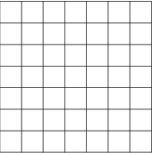
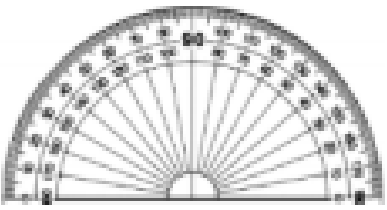
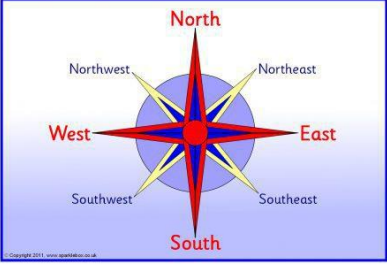
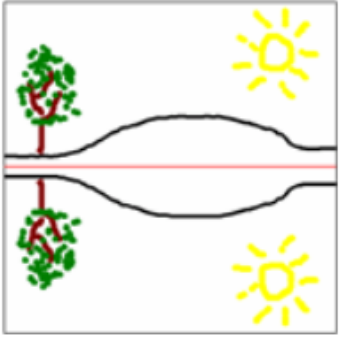
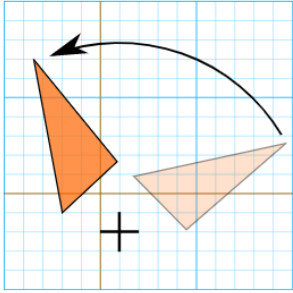
Grid	A series of evenly divided and equally spaced shapes, usually squares.	
Plot	To mark out a point on a graph or grid.	<i>'Plot the point (3,6) means to draw the precise location of that point, usually shown as a dot or a small cross'.</i>
Point	The precise location of a position on a 2-D plane.	<i>'An exact place on a graph or on squared paper. A point can be represented by a capital letter.'</i>
Protractor/angle measurer	A measuring device for measuring the size of an angle. Angles are measured in degrees (°).	
North-east, north-west, south-east, south-west, NE, NW, SE, SW	Compass directions	
Reflection	An image or shape as it would be seen in a mirror.	
Rotation	The action of rotating about an axis or centre.	

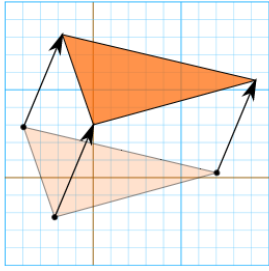
Set square	A right-angled triangular plate for drawing lines, especially at 90°, 45°, 60°, or 30°.	
Translation	"Sliding": moving a shape without rotating or flipping it. The shape still looks exactly the same, just in a different place.	

Statistics

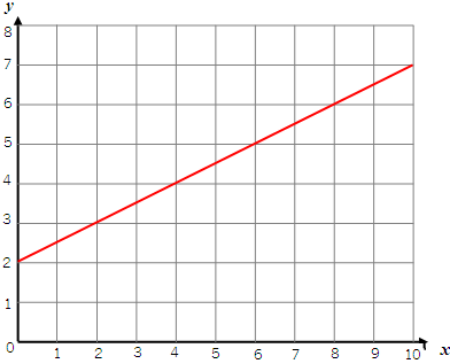
Data	A collection of facts, such as numbers, words, measurements, observations or even just descriptions of things.	<p><i>"What sport do you play?"</i></p> <table border="1" data-bbox="1008 860 1286 1061"> <thead> <tr> <th>Sport</th> <th>People</th> </tr> </thead> <tbody> <tr> <td>Soccer</td> <td>106</td> </tr> <tr> <td>Tennis</td> <td>45</td> </tr> <tr> <td>Gymnastics</td> <td>54</td> </tr> <tr> <td>Swimming</td> <td>82</td> </tr> <tr> <td>Track</td> <td>68</td> </tr> </tbody> </table>	Sport	People	Soccer	106	Tennis	45	Gymnastics	54	Swimming	82	Track	68
Sport	People													
Soccer	106													
Tennis	45													
Gymnastics	54													
Swimming	82													
Track	68													
Interval	An interval on a graph's axis lies between two values.	<p><i>'The graph below is going up in intervals of 1.'</i></p> 												
Survey	To gather information by individual samples so we can learn about the whole thing.	<p><i>'We are going to complete a survey of children's favourite ice cream flavour'.</i></p>												
Time graph	A graph that uses lines to connect the points on a data chart. Used to present continuous data, such as change over time.	